

CCT-3300 Series Conductivity Controller

Operation Manual

Introduction

Thanks for your choosing CCT-3300 series conductivity/resistivity controller manufactured by Hebei Create Instrumentation Technologies Co., Ltd. Correct sensor installation and parameter setting would show great performance and advantage of this instrument for your good usage. So please carefully read this manual before installation.

This instrument is a precise electrochemical analysis meter, which the installation and operation should be performed by technicians with relevant professional knowledge.

Please contact technical support department of CREATE when you meet any problems during installation and usage.

Check the actual product with complete set after you receive the package, and contact us if any missing or damage.

Our serious promise:

1. The meter's quality guarantee is one year from the date of purchasing. During this period, if the meter has quality problems, manufacture is responsible for maintenance work for free or changes it.

2. We provide lifelong maintenance service for the product whatever you purchase from us or distributors.

3. If the damage of the meter is caused by the following reasons, it is out of the maintenance service:

A).The meter is burned caused by misconnection with high voltage power supply or soggy.

B).The meter is refitted or misused without permission.

C).The meter is damaged under the condition out of use environment.

D).The relevant damage caused by choosing the wrong type.

E).The physical damage caused by ultimate load

F).The meter is out of operation caused by improper storage and transportation

(refer to SJ/T10463-93 standard)

G).Consumable material is out of maintenance service and need purchase separately..

⚠ Please pay more attention when this symbol appears in this manual which refers to safe, installation, product functions and usage.

⚠

Without the influence on the operation, any small changes or improvement on the products by the manufacture will not be notified separately. Please make the object as the standard.

Content

I . General.....	1
1.1 Applications.....	1
1.2 Classifications.....	1
1.3 Technical Features.....	1
II . Installation.....	2
2.1 Electrical connection.....	2
2.2 Installation of electrode.....	3
III . Settings.....	5
3.1 Mode settings.....	6
3.1.1 Electrode type setting.....	7
3.1.2 Electrode constant setting.....	7
V . Complete set.....	10
VI . Order Directory.....	10

I . General

CCT-3300 series is a new developed conductivity/resistivity integration controller manufactured by Hebei Create Instrumentation Technologies Co., Ltd.

Please select the suitable electrode in application. You could only set the electrode type in the menu, and the instrument could run in conductivity or resistivity measurement automatically.

The engineer unit could be selected according to your requirement without any announcement when you place an order.

1.1 Applications

- ✧ High pure/ultrapure water measurement control, widely used for electronic, electric, pharmacy, fine chemistry, clinical medicine, life science.
- ✧ This series products are widely used for monitoring of all water treatment process, which have high performances in high salt water treatment, concentrated solution, recirculating cooling water, reclaimed water and ect.

1.2 Classifications

model	Power supply	frequency (Hz)	Current loop modes	control mode	Constant selection (cm ⁻¹)
CCT-3300E	DC24V	-----	Instrument/Transmitter	SPDT relay	0.01~10.0
CCT-3310E	AC110V	50/60	Instrument/Transmitter	SPDT relay	0.01~10.0
CCT-3320	AC220V	50/60	Instrument/Transmitter	SPDT relay	0.01~10.0
CCT-3320T	AC220V	50/60	Instrument/Transmitter	no	0.01~10.0
CCT-3320E	AC220V	50/60	Instrument/Transmitter	SPDT relay	0.01~10.0

Note: The model with E is the EMC enhancement type.

1.3 Technical Features

Model	CCT-3300 Series Conductivity Controller			
Conductivity cell model	CON2136-13	CON1134-13	CON3133-13	CON3131-13
constant	10.00cm ⁻¹	1.000cm ⁻¹	0.100cm ⁻¹	0.010cm ⁻¹
Measurement range	(0.5~20) mS/cm	(1.0~2000) μS/cm	(0.5~200) μS/cm	(0.05~18.25) MΩ·cm
Measurement	Measurement range		resolution	accuracy

parameter			
Conductivity	0.50 μ S/cm~20.00mS/cm	0.01 μ S/cm	1.5
Resistivity	0.05M Ω ·cm~18.25M Ω ·cm	0.01M Ω ·cm	2.0
TDS	0.25ppm~10.00ppt	0.01ppm	1.5
Temp.	0~50 $^{\circ}$ C	0.1 $^{\circ}$ C	\pm 0.5 $^{\circ}$ C
Temp. element	NTC10K		
4-20mA output	Isolated, reversible, adjustable, instrument/transmitting mode for selection Loop resistance 400 Ω (Max) DC24V		
Control contact	SPDT relay, Load capacity AC230V/5A (Max) Note: CCT-3320T has no relay		
Storage environment	Temp: (-20~60) $^{\circ}$ C relative humidity: \leq 85%RH (none condensation)		
Working environment	Temp: (0~50) $^{\circ}$ C relative humidity: \leq 85%RH (none condensation)		
Dimension	48 mm \times 96 mm \times 80mm (H \times W \times D)		
Installation	44mm \times 92mm/Panel mounted, fast installation		

II. Installation

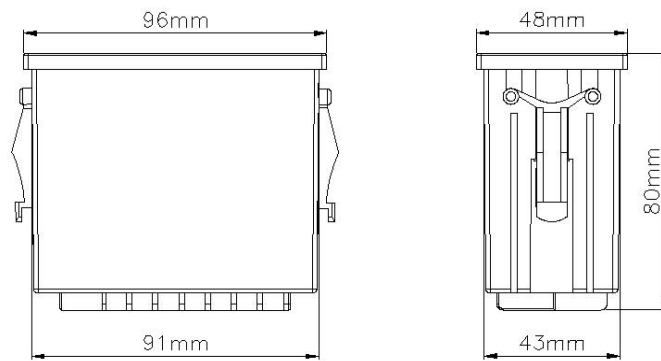

Dimension



Do not place the LCD display screen under the sun for the UV could damage the screen.

2.1 Electrical connection

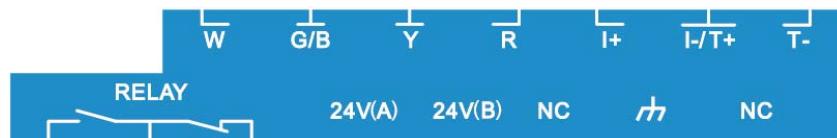

CCT-3300E



CCT-3310E

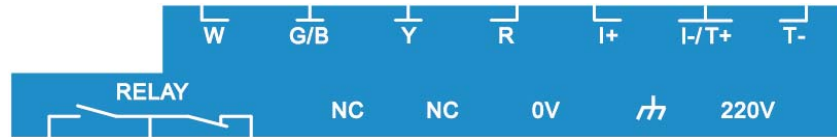

CCT-3320E/CCT-3320

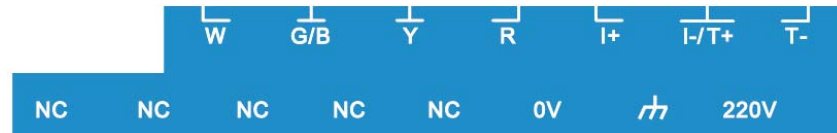

CCT-3320T

Wiring instruction:

W	Connect white line of cell (WHITE)
G/B	Connect green line of cell (GREEN)
Y	Connect yellow line of cell (YELLOW)
R	Connect red line of cell (RED)
I+/I-	Instrument mode (powered by instrument)
T+/T-	Transmitting mode (powered by conditioning module)
RELAY	Relay contact (SPDT NO/NC)
24V(A)/24V(B)	DC power supply (automatic internal recognition polarity)
0V/110V	AC 110V input interface
0V/220V	AC 220V input interface
	Electromagnetic compatibility ground protection terminal(connect the earth)
NC	Empty terminal (no connection inside)

2.2 Installation of electrode

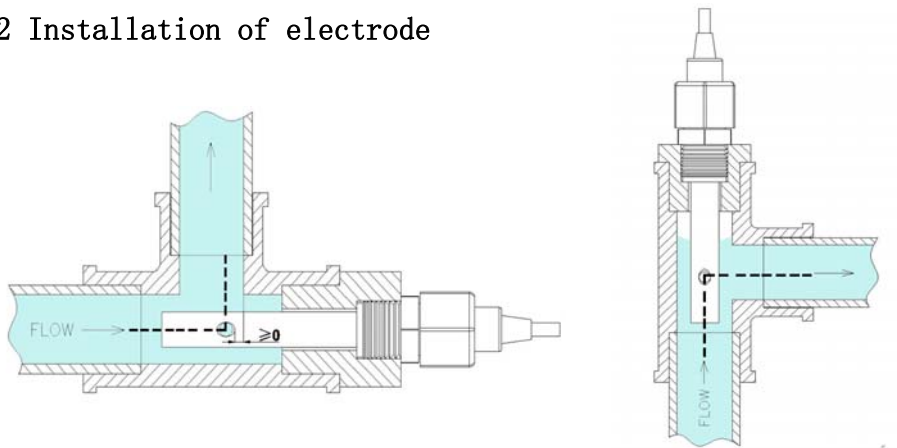

Correct installation modes of probe

Please strictly select installation position and installation mode. Since the incorrect installation will cause the reading error.

- 1) The electrode should be installed in a place in the circulating and closed pipeline where the stream is steady and air bubbles are hard to generate.
- 2) No matter the concentric electrode is horizontally, slant or vertically installed, the front head should be deeply inserted into the moving water and face to water flow direction installation.
- 3) The conductivity signal is weak electronic signal and its collecting cable should be separately installed. When threading cable joint or connecting terminal board is used, to avoid wetting interference or breakdown of measurement unit circuit, they should not be connected to the same group of cable joint or terminal board with the power line or control line.
- 4) The cable of electrode is special cable and has standard length before leaving factory. Any customization for the cable length, it's recommended to make an agreement with the factory before placing an order.
- 5) Please keep the measuring part of electrode clean, and do not directly contact the surface by hands or contact with the oil stain objects to avoid inaccurate measurement.
- 6) Electrode is a kind of precision components, so please do not change any part of the electrode. The accuracy will be incorrect if the electrode was destroyed by the strong acid, strong alkali, scrape from machine and etc.
- 7) The meter is made by precision integrated circuit and electronic components, so it needs to place in case or dry environment.
- 8) In order to guarantee the safety operation, please checking after installation then switch on.



III. Settings

Please enter into the setting mode to check and set the relative parameters for your first use. These parameters are in different menus.

⚠ The starting time for this instrument is about 10 seconds and the measurement data during this time is invalid.



Front view

	Select key	1. select thousand, hundred ,ten and unit in circulate under parameter setting interface 2. switch to display conductivity/TDS/resistivity under measurement condition
	Add key	1. Adjust the value under parameter setting status. 2. Check the temperature/mA reading under measurement status.
	Enter key	1. Enter parameter setting under main menu 2. Save the parameters and enter next menu

Two operation modes for CCT-3300 series :

- ◆ measurement mode : normal display/transient display
- ◆ setting mode : for parameter setting

switch diagram :

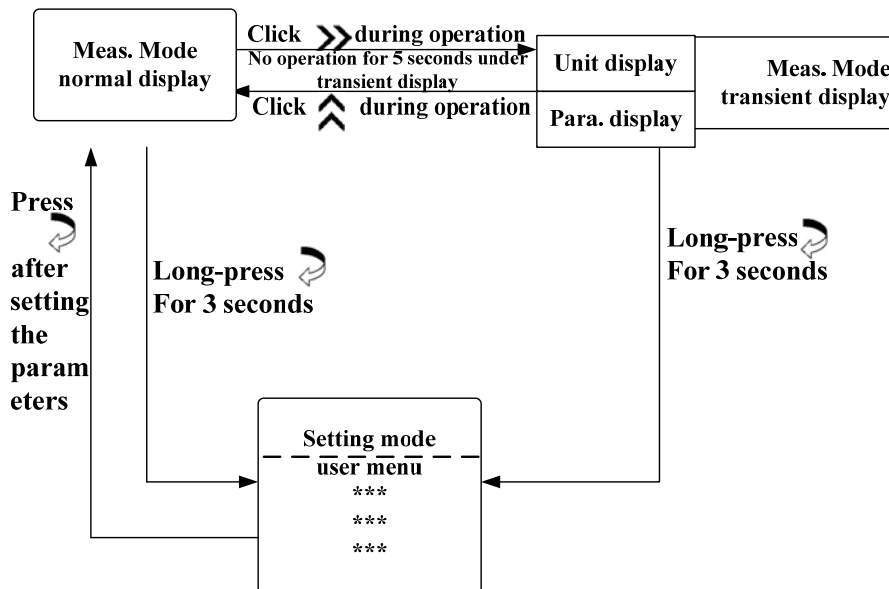

3.1 Mode settings

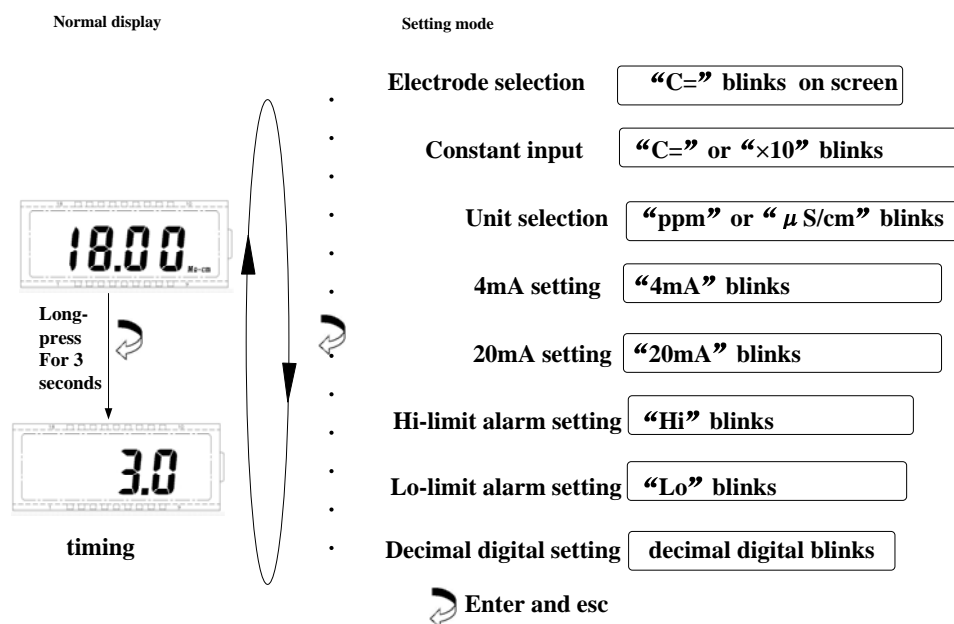

Some parameters have been set before leaving factory. If the test environment changes (such as replacement of electrode, reset the alarm setting), please check the parameter which is in different menus. The specific content and operations as follows:



⚠ The setting value of 4mA and 20mA can not be equal. !!

⚠ The decimal digits setting is only for C=0.01 cm⁻¹ electrode selection.

3.1.1 Electrode type setting

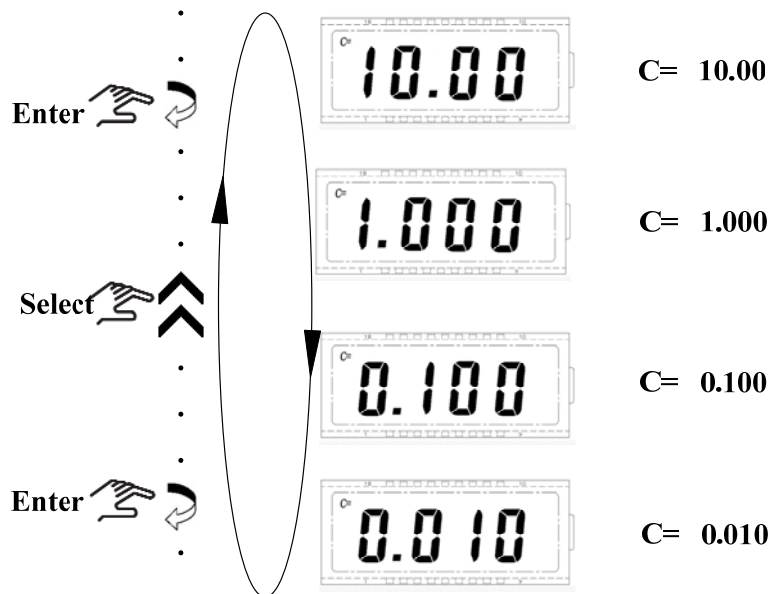

When the meter shows “C=”, you could select electrode type. The electrode type could be circulated display for your selection by pressing . Choose your wanted type and press  to save your settings and enter into the next menu setting automatically.

Enter into the type setting and select the electrode type:



 In general, C=0.010 electrode is special used for high pure water measurement. For C=10.00/1.000/0.100 electrode, they are used for pure water, clear water and polluted water measurement. The engineer unit could be modified.

3.1.2 Electrode constant setting

After constant selection, the instrument would enter into the constant correction menu and this screen would display constant level. Digit position blinks means the value could be modified. Press  to modify the position of digital and press  to input the needed value. Then press  to save the setting values and enter into the next menu.

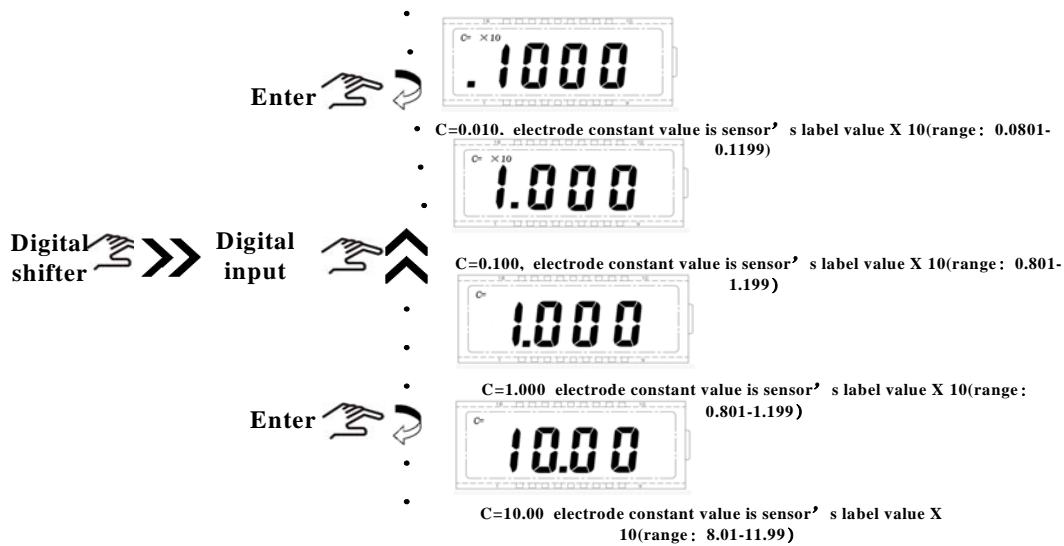

When accurate setting for C=0.010 and C=0.100, the shift x 10 blinks to prompt extension ratio due to the screen display adopt X10 mode.

IV. Failure judgement

When the reading is incorrect or unstable, please check the meter and electrode.

1. Under resistivity measurement condition, remove the white wire from the wire terminal and check the resistivity reading, if the reading is $18.23\text{M}\Omega\cdot\text{cm}$ and stable, the meter is good. The problem can be initially identified from the electrode installation.
2. Under conductivity measurement condition, remove the white wire from the wire terminal and check the conductivity reading, if the reading is zero and stable, the meter is good. The problem can be initially identified from the electrode installation.
 - 1) Connect the white and green terminals on the short-circuit meter and check the resistivity reading, if the reading is $0.0\text{M}\Omega\cdot\text{cm}$, the meter is good. The problem can be initially identified from the electrode installation.
 - 2) Meter mode or transmitter mode of (4~20)mA judgment.

Before the judgment please makes sure there is no wire connection on the terminal.

mA mode	Output terminal	voltage of terminal	voltage of cable
Meter mode	I+/I-	>12V DC	no
Transmitter mode	T+/T-	no	DC24V

General fault inspection and trouble shooting:

phenomenon	Possible factor	trouble shooting methods
No reading after powered	A. No power supply connection B. Instrument fault	A. Check the wire connection of power supply B. Maintained by professional.
Unstable reading	A. Incorrect wire connection of Cell B. there is bubble in the pipeline C. the water quality is not stable	A. check the wire connection according to the instruction and change if incorrect. B. change the pipeline or select another measurement point C. Use stable water quality to check the problem reason
Serious error of reading	A. Incorrect constant Setting B. The electrode constant is changed C. Inappropriate flow speed of measured point D. Incorrect electrode installation	A. Reset the electrode constant B. Replace a new electrode or reset the electrode constant. C. Choose a new installation position D. Install the electrode according to the installation instruction.
different mA reading between sender and receiver	A. Reviver transfer error B. Not up to 20mA C. Incorrect setting on sending D. mA transfer error	A. Reset the transfer setting again B. Loop resistance is too large, enlarge the cable. C. Set the corresponding of mA and reading again. D. Use the ammeter to check the current.

NOTE:

1. High pure water and ultrapure water could not select open sampling measurement method. If the high pure water is exposed to the air, a lot of carbon dioxide would dissolve into the water immediately and the impurity inside the container and dusts in the air would also dissolve into the water which could cause serious errors. So high pure water could only adopt inclosed, running and side flow circulation method. With open measurement method to test high pure water by using laboratory appliance is inadvisable.

2. Resin regeneration dirt would pollute the cell, please clean by alcohol cotton ball.

V. Complete set

Conductivity /TDS transmitting controller	one piece (with a pair of fast installation clamp)
Electrode	one piece
Operation menu	one piece

VI. Order Directory

Please check the below items to choose the suitable power supply, cell constant, material, fixed method for your applications

Model	power supply	cell constant	connection	electrode material
CCT-3300E	<input type="checkbox"/> DC 24V	<input type="checkbox"/> 0.01 cm ⁻¹ <input type="checkbox"/> 0.10 cm ⁻¹ <input type="checkbox"/> 1.00 cm ⁻¹ <input type="checkbox"/> 10.00 cm ⁻¹	<input type="checkbox"/> thread <input type="checkbox"/> ferrule	<input type="checkbox"/> 316L+titanium
CCT-3310E	<input type="checkbox"/> AC 110V			<input type="checkbox"/> 316L
CCT-3320E	<input type="checkbox"/> AC 220V		<input type="checkbox"/> 316L	
CCT-3320	<input type="checkbox"/> AC 220V		<input type="checkbox"/> plastic	
CCT-3320T	<input type="checkbox"/> AC 220V		<input type="checkbox"/> graphite	

[NOTE]: The standard cable length is 5 meters for C=10.0 cm⁻¹、1.0 cm⁻¹、0.1 cm⁻¹ electrode. While the standard cable length is 10 meters for C=0.01 cm⁻¹ electrode. (please indicate another special length before placing an order)

- 1) All the products would be standard configuration if you have no other requirements. For customization cable length, please indicate before placing an order.
- 2) Please select the suitable electrode according to your measured media to get accurate measurement data and resolution before placing an order.
- 3) To purchase 24V electronic transducer, please indicate the AC power supply when you place the order.